



# USER'S MANUAL

## DIGI SCAN 1600™



**MODEL: DSV1600**

## SCAN 1600



**MODEL: SSV1600**

**SAFETY INSTRUCTIONS**

All of the safety and operating instructions should be read before the product is operated and should be retained for further reference. Please follow all of the warnings on this product and its operating instructions.

**CAUTION:**

**WARNING:** To prevent the risk of electric shock and fire, do not expose this device to rain, humidity or intense heat sources (such as heaters or direct sunlight). Slots and openings in the device are provided for ventilation and to avoid overheating. Make sure the device is never placed on or near a textile surface that could block the openings. Also keep away from excessive dust, vibrations and shocks.

**POWER:** Only use the power supply indicated on the device or on the power source. Devices equipped with a grounding plug should only be used with a grounding type outlet. In no way should this grounding be modified, avoided or suppressed.

**POWER CORD:** Use the On (I) / Off (O) switch to power On or Off devices equipped with that switch. All other devices should be plugged and unplugged from wall outlet. In both cases, please follow these instructions:

- The power cord of the device should be unplugged from the outlet when left unused for several days.
- To unplug the device, do not pull on the power cord but always on the plug itself.
- The outlet should always be near the device and easily accessible.
- Power supply cords should be routed so that they are not likely to be walked on or pinched by items placed upon or against them.

If the power supply cord is damaged, unplug the device. Using the device with a damaged power supply cord may expose you to electric shocks or other hazards. Verify the condition of the power supply cords once in a while. Contact your dealer or service center for replacement if damaged.

**CONNECTIONS:** All inputs and outputs (except for the power input) are TBTS defined under EN60950.

**SERVICING:** Do not attempt to service this product yourself by opening or removing covers and screws since it may expose you to electric shocks or other hazards. Refer all problems to qualified service personnel.

**OPENINGS:** Never push objects of any kind into this product through the openings. If liquids have been spilled or objects have fallen into the device, unplug it immediately and have it checked by a qualified technician.

## **ISTRUZIONI DE SÉCURITÉ**

Afin de mieux comprendre le fonctionnement de cet appareil nous vous conseillons de bien lire toutes les consignes de sécurité et de fonctionnement de l'appareil avant utilisation. Conserver les instructions de sécurité et de fonctionnement afin de pouvoir les consulter ultérieurement. Respecter toutes les consignes marquées dans la documentation, sur le produit et sur ce document.

**ATTENTION :** Afin de prévenir tout risque de choc électrique et d'incendie, ne pas exposer cet appareil à la pluie, à l'humidité et aux sources de chaleur intense.

**INSTALLATION :** Veillez à assurer une circulation d'air suffisante pour éviter toute surchauffe à l'intérieur de l'appareil. Ne placez pas l'appareil sur ou proximité de surface textile susceptible d'obstruer les orifices de ventilation. N'installez pas l'appareil à proximité de sources de chaleur comme un radiateur ou une bouche d'air chaud, ni dans un endroit exposé au rayonnement solaire direct, à des poussières excessives, à des vibrations ou à des chocs mécaniques. Ceci pourrait provoquer un mauvais fonctionnement et un accident.

**ALIMENTATION :** Ne faire fonctionner l'appareil qu'avec la source d'alimentation indiquée sur l'appareil ou sur son bloc alimentation. Pour les appareils équipés d'une alimentation principale avec fil de terre, ils doivent être obligatoirement connectés sur une source équipée d'une mise à la terre efficace. En aucun cas cette liaison de terre ne devra être modifiée, contournée ou supprimée.

**CORDON D'ALIMENTATION :** Pour les appareils équipés d'un interrupteur général (Marche I / Arrêt O), la mise sous tension et la mise hors tension se fait en actionnant cet interrupteur général. Pour les appareils sans interrupteur général, la mise sous tension et la mise hors tension se fait directement en connectant et déconnectant le cordon d'alimentation de la prise murale.

Dans les 2 cas ci-dessus appliquer les consignes suivantes :

- Débrancher le cordon d'alimentation de la prise murale si vous prévoyez de ne pas utiliser l'appareil pendant quelques jours ou plus.
- Pour débrancher le cordon, tirez le par la fiche. Ne tirez jamais sur le cordon proprement dit.
- La prise d'alimentation doit se trouver à proximité de l'appareil et être aisément accessible.
- Ne laissez pas tomber le cordon d'alimentation et ne posez pas d'objets lourds dessus.

Si le cordon d'alimentation est endommagé, débranchez le immédiatement de la prise murale. Il est dangereux de faire fonctionner cet appareil avec un cordon endommagé, un câble abîmé peut provoquer un risque d'incendie ou un choc électrique. Vérifier le câble d'alimentation de temps en temps. Contacter votre revendeur ou le service après vente pour un remplacement.

**CONNEXIONS :** Toutes les entrées et sorties (exceptée l'entrée secteur) sont de type TBTS (Très Basse Tension de Sécurité) définies selon EN 60950.

**RÉPARATION ET MAINTENANCE :** L'utilisateur ne doit en aucun cas essayer de procéder aux opérations de dépannage, car l'ouverture des appareils par retrait des capots ou de toutes autres pièces constituant les boîtiers ainsi que le dévissage des vis apparentes à l'extérieur, risque d'exposer l'utilisateur à des chocs électriques ou autres dangers. Contacter le service après vente ou votre revendeur ou s'adresser à un personnel qualifié uniquement.

**OUVERTURES ET ORIFICES :** Les appareils peuvent comporter des ouvertures (aération, fentes, etc...), veuillez ne jamais y introduire d'objets et ne jamais obstruer ses ouvertures. Si un liquide ou un objet pénètre à l'intérieur de l'appareil, débranchez immédiatement l'appareil et faites le contrôler par un personnel qualifié avant de le remettre en service.

## **ISTRUZIONI DI SICUREZZA**

Allo scopo di capire meglio il funzionamento di questa apparecchiatura vi consigliamo di leggere bene tutti i consigli di sicurezza e di funzionamento prima dell'utilizzo. Conservare le istruzioni di sicurezza e di funzionamento al fine di poterle consultare ulteriormente. Seguire tutti i consigli indicati su questo manuale e sull'apparecchiatura.

**ATTENZIONE :** Al fine di prevenire qualsiasi rischio di shock elettrico e d'incendio, non esporre l'apparecchiatura a pioggia, umidità e a sorgenti di eccessivo calore.

**INSTALLAZIONE :** Assicuratevi che vi sia una sufficiente circolazione d'aria per evitare qualsiasi surriscaldamento all'interno dell'apparecchiatura. Non collocare l'apparecchiatura in prossimità o su superfici tessili suscettibili di ostruire il funzionamento della ventilazione. Non installate l'apparecchiatura in prossimità di sorgenti di calore come un radiatore o una fuoruscita d'aria calda, né in un posto esposto direttamente ai raggi del sole, a polvere eccessiva, a vibrazioni o a shock meccanici. Ciò potrebbe provocare un erroneo funzionamento e un incidente.

**ALIMENTAZIONE :** Far funzionare l'apparecchiatura solo con la sorgente d'alimentazione indicata sull'apparecchiatura o sul suo alimentatore. Per le apparecchiature fornite di un'alimentazione principale con cavo di terra, queste devono essere obbligatoriamente collegate su una sorgente fornita di una efficiente messa a terra. In nessun caso questo collegamento potrà essere modificato, sostituito o eliminato.

**CAVO DI ALIMENTAZIONE :** Per le apparecchiature fornite di interruttore generale (Acceso I / Spento O), l'accensione e lo spegnimento dell'apparecchiatura si effettuano attraverso l'interruttore. Per le apparecchiature senza interruttore generale, l'accensione e lo spegnimento si effettuano direttamente inserendo o disinserendo la spina del cavo nella presa murale.

In entrambe i casi applicare i seguenti consigli :

- Disconnettere l'apparecchiatura dalla presa murale se si prevede di non utilizzarla per qualche giorno.
- Per disconnettere il cavo tirare facendo forza sul connettore.
- La presa d'alimentazione deve trovarsi in prossimità dell'apparecchiatura ed essere facilmente accessibile.
- Non far cadere il cavo di alimentazione né appoggiarci sopra degli oggetti pesanti.

Se il cavo di alimentazione è danneggiato, spegnere immediatamente l'apparecchiatura. E' pericoloso far funzionare questa apparecchiatura con un cavo di alimentazione danneggiato, un cavo graffiato può provocare un rischio di incendio o uno shock elettrico. Verificare il cavo di alimentazione spesso. Contattare il vostro rivenditore o il servizio assistenza per una sostituzione.

**CONNESSIONE :** Tutti gli ingressi e le uscite (eccetto l'alimentazione) sono di tipo TBTS definite secondo EN 60950.

**RIPARAZIONI E ASSISTENZA :** L'utilizzatore non deve in nessun caso cercare di riparare l'apparecchiatura, poiché con l'apertura del coperchio metallico o di qualsiasi altro pezzo costituente la scatola metallica, nonché svitare le viti che appaiono esteriormente, poiché ciò può provocare all'utilizzatore un rischio di shock elettrico o altri rischi.

**APERTURE DI VENTILAZIONE :** Le apparecchiature possono comportare delle aperture di ventilazione, si prega di non introdurre mai oggetti o ostruire le sue fessure. Se un liquido o un oggetto penetra all'interno dell'apparecchiatura, disconnetterla e farla controllare da personale qualificato prima di rimetterla in servizio.

## **SICHERHEITSHINWEISE**

Um den Betrieb dieses Geräts zu verstehen, raten wir Ihnen vor der Inbetriebnahme alle Sicherheits- und Betriebsanweisungen genau zu lesen. Diese Sicherheits- und Betriebsanweisungen für einen späteren Gebrauch sicher aufbewahren. Alle in den Unterlagen, an dem Gerät und hier angegebenen Sicherheitsanweisungen einhalten.

### VORSICHT & WARNUNG

**ACHTUNG:** um jegliches Risiko eines Stromschlags oder Feuers zu vermeiden, das Gerät nicht Regen, Feuchtigkeit oder intensiven Wärmequellen aussetzen.

**EINBAU :** Eine ausreichende Luftzufuhr sicherstellen, um jegliche Überhitzung im Gerät zu vermeiden. Das Gerät nicht auf und in Nähe von Textiloberflächen, die Belüftungsöffnungen verschließen können, aufstellen. Das Gerät nicht in Nähe von Wärmequellen, wie z.B. Heizkörper oder Warmluftkappe, aufstellen und es nicht dem direkten Sonnenlicht, übermäßigem Staub, Vibrationen oder mechanischen Stößen aussetzen. Dies kann zu Betriebsstörungen und Unfällen führen.

**STROMVERSORGUNG :** Das Gerät nur mit der auf dem Gerät oder dem Netzteil angegebenen Netzspannung betreiben. Geräte mit geerdeter Hauptstromversorgung müssen an eine Stromquelle mit effizienter Erdung angeschlossen werden. Diese Erdung darf auf keinen Fall geändert, umgangen oder entfernt werden.

**STROMKABEL :** Für Geräte mit einem Hauptschalter (Ein/Aus) erfolgt die Stromversorgung und Unterbrechung mittels dieses Hauptschalters. Geräte ohne Hauptschalter werden durch das Einstecken oder Herausziehen des Steckers in den Wandanschluß ein- oder ausgeschaltet. Für beide Fälle gelten folgende Richtlinien:

- Den Stecker aus dem Wandanschluß herausziehen wenn Sie das Gerät mehrere Tage oder länger nicht benutzen.
- Das Kabel mittels dem Stecker herausziehen. Niemals am Stromkabel selbst ziehen.
- Die Steckdose muß sich in der Nähe des Geräts befinden und leicht zugänglich sein.
- Das Stromkabel nicht fallen lassen und keine schweren Gegenstände auf es stellen.

Wenn das Stromkabel beschädigt ist, das Gerät sofort abschalten. Es ist gefährlich das Gerät mit einem beschädigten Stromkabel zu betreiben; ein abgenutztes Kabel kann zu einem Feuer oder Stromschlag führen. Das Stromkabel regelmäßig untersuchen. Für den Ersatz, wenden Sie sich an Ihren Verkäufer oder Kundendienststelle.

**ANSCHLÜSSE :** Bei allen Ein- und Ausgängen (außer der Stromversorgung) handelt es sich, gemäß EN 60950, um Sicherheits- Kleinspannungsanschlüsse.

**REPARATUR UND WARTUNG :** Der Benutzer darf keinesfalls versuchen das Gerät selbst zu reparieren, die Öffnung des Geräts durch Abnahme der Abdeckhaube oder jeglichen anderen Teils des Gehäuses sowie die Entfernung von außen sichtbaren Schrauben zu Stromschlägen oder anderen Gefahren für den Benutzer führen kann. Wenden Sie sich an Ihren Verkäufer, Ihre Kundendienststelle oder an qualifizierte Fachkräfte.

**ÖFFNUNGEN UND MUNDUNGEN :** Die Geräte können über Öffnungen verfügen (Belüftung, Schlitze, usw.). Niemals Gegenstände in die Öffnungen einführen oder die Öffnungen verschließen. Wenn eine Flüssigkeit oder ein Gegenstand in das Gerät gelangt, den Stecker herausziehen und es vor einer neuen Inbetriebnahme von qualifiziertem Fachpersonal überprüfen lassen.

## **INSTRUCCIONES DE SEGURIDAD**

Para comprender mejor el funcionamiento de este aparato, le recomendamos que lea cuidadosamente todas las consignas de seguridad y de funcionamiento del aparato antes de usarlo. Conserve las instrucciones de seguridad y de funcionamiento para que pueda consultarlas posteriormente. Respete todas las consignas indicadas en la documentación, relacionadas con el producto y este documento.

### PRECAUCIONES Y OBSERVACIONES

**CUIDADO :** Para prevenir cualquier riesgo de choque eléctrico y de incendio, no exponga este aparato a la lluvia, a la humedad ni a fuentes de calor intensas.

**INSTALACIÓN :** Cerciórese de que haya una circulación de aire suficiente para evitar cualquier sobrecalentamiento al interior del aparato. No coloque el aparato cerca ni sobre una superficie textil que pudiera obstruir los orificios de ventilación. No instale el aparato cerca de fuentes de calor como radiador o boca de aire caliente, ni en un lugar expuesto a los rayos solares directos o al polvo excesivo, a las vibraciones o a los choques mecánicos. Esto podría provocar su mal funcionamiento o un accidente.

**ALIMENTACIÓN :** Ponga a funcionar el aparato únicamente con la fuente de alimentación que se indica en el aparato o en su bloque de alimentación. Los aparatos equipados con una alimentación principal con hilo de tierra deben estar conectados obligatoriamente a una fuente equipada con una puesta a tierra eficaz. Por ningún motivo este enlace de tierra deberá ser modificado, cambiado o suprimido.

**CABLE DE ALIMENTACIÓN :** Para los aparatos equipados con un interruptor general (Marcha I / Paro O), la puesta bajo tensión y la puesta fuera de tensión se hace accionando este interruptor general.. En los aparatos que no tienen interruptor general, la puesta bajo tensión y la puesta fuera de tensión se hace directamente conectando y desconectando el enchufe mural.

En ambos casos, se deberá respetar las siguientes consignas:

- Desconectar el aparato del enchufe mural si no piensa utilizarlo durante varios días.
- Para desconectar el cable, tire de la clavija. No tire nunca del cable propiamente dicho.
- El enchufe de alimentación debe estar cerca del aparato y ser de fácil acceso.
- No deje caer el cable de alimentación ni coloque objetos pesados encima de él.

Si el cable de alimentación sufre algún daño, ponga el aparato inmediatamente fuera de tensión. Es peligroso hacer funcionar este aparato con un cable averiado, ya que un cable dañado puede provocar un incendio o un choque eléctrico. Verifique el estado del cable de alimentación de vez en cuando. Póngase en contacto con su distribuidor o con el servicio de posventa si necesita cambiarlo.

**CONEXIONES :** Todas las entradas y salidas (excepto la entrada del sector) son de tipo TBTS (Muy Baja Tensión de Seguridad) definidas según EN 60950.

**REPARACIÓN Y MANTENIMIENTO :** Por ningún motivo, el usuario deberá tratar de efectuar operaciones de reparación, ya que si abre los aparatos retirando el capó o cualquier otra pieza que forma parte de las cajas o si destornilla los tornillos aparentes exteriores, existe el riesgo de producirse una explosión, choques eléctricos o cualquier otro incidente. Contacte el servicio de posventa, a su distribuidor o diríjase con personal cualificado únicamente.

**ABERTURAS Y ORIFICIOS :** Los aparatos pueden contener aberturas (aireación, ranuras, etc.). No introduzca allí ningún objeto ni obstruya nunca estas aberturas. Si un líquido o un objeto penetra al interior del aparato, desconéctelo y hágalo revisar por personal cualificado antes de ponerlo nuevamente en servicio.

**TABLE OF CONTENTS**

SAFETY INSTRUCTIONS .....2

QUICK START GUIDE – DIGI SCAN 1600 .....6

QUICK START GUIDE – SCAN 1600.....7

Chapter 1 : INTRODUCTION .....8

    1-1. ACCESSORIES SUPPLIED WITH THE DIGI SCAN 1600.....8

    1-2. ACCESSORIES SUPPLIED WITH THE SCAN 1600.....8

    1-3. DIGI SCAN 1600 GENERAL INFORMATION .....8

    1-4. SCAN 1600 GENERAL INFORMATION.....9

    1-5. DEVICES & OPTIONS REFERENCES .....9

    1-6. INSTALLATION.....9

    1-7. DIGI SCAN 1600 FRONT PANEL DESCRIPTION .....10

    1-8. DIGI SCAN 1600 REAR PANEL DESCRIPTION .....10

    1-9. SCAN 1600 FRONT PANEL DESCRIPTION .....11

    1-10. SCAN 1600 REAR PANEL DESCRIPTION.....11

Chapter 2 : STARTING .....12

    2-1. DIGI SCAN 1600 CONNECTIONS: .....12

    2-2. SCAN 1600 CONNECTIONS:.....13

    2-3. SETTINGS.....13

    2-4. IMAGE ADJUSTMENTS .....13

Chapter 3 : FRONT PANEL DISPLAY MENU DESCRIPTION .....14

    3-1. INTRODUCTION .....14

    3-2. CONTROL BUTTONS .....14

    3-3. STATUS MODE.....14

    3-4. CONTROL MODE.....15

    3-5. FUNCTIONS DESCRIPTION .....16

Chapter 4 : UPDATING THE DEVICE .....18

Chapter 5 : REMOTE CONTROL SOFTWARE.....19

    5-1. CONNECTIONS .....19

    5-2. SOFTWARE INSTALLATION .....19

    5-3. COMMUNICATION SETUP.....19

    5-4. USING THE SOFTWARE .....20

Chapter 6 : TECHNICAL SPECIFICATIONS .....22

    6-1. COMPUTER INPUTS .....22

    6-2. VIDEO OUTPUTS .....22

    6-3. GENLOCK .....23

    6-4. REMOTE PORT.....23

    6-5. ENVIRONMENTAL .....23

APPENDIX A: PROGRAMMER'S GUIDE.....24

WARRANTY.....28





# QUICK START GUIDE – DIGI SCAN 1600

ANALOG WAY

EDITION : 06/07

## CONNECTIONS:

- ① Turn OFF all of your equipment before connecting.
- ② Connect the AC power supply cord to the DIGI SCAN 1600 and to an AC power outlet.
- ③ Connect your computer source to the COMPUTER INPUT (HD15) connector or the DVI-D INPUT connector.
- ④ As required, connect a control monitor on the MONITOR OUT (HD15) connector.

**NOTE:** Set the RGB Hi-Z/75 Ω button on Hi-Z if you connect a monitor on the MONITOR OUT connector. If not set it on 75 Ω.

**NOTE:** The MONITOR OUT is available only if the COMPUTER source is analog.

- ⑤ Connect your display devices (TV monitor, VCR...) to the outputs (analog or SDI).
- ⑥ Turn ON the DIGI SCAN 1600 (rear panel switch). Then turn ON your input source and then your display devices.

### • DIGI SCAN 1600 connection diagram:

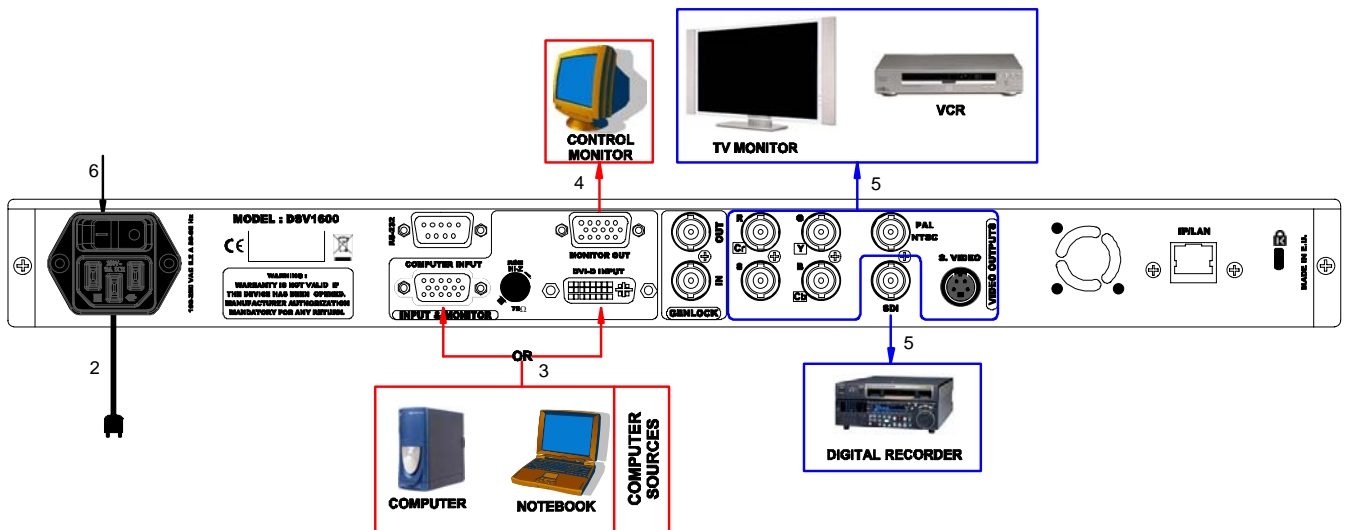

### • RGB/COMPONENT output connection:

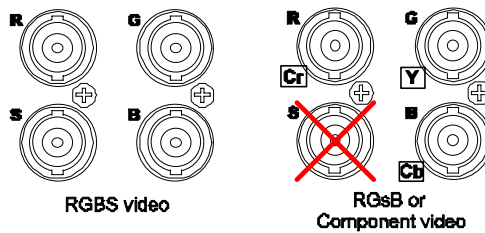

## SETTINGS:

- ① We recommend resetting the DIGI SCAN 1600 to all of its default values, with the front panel display menu (**Control > default value > yes**) before proceeding.
- ② Select the Input source (ANALOG or DVI) with the front panel display menu (**Input > Input select.**).
- ③ Select the Output standard with the front panel display menu (**Output > output std.**).
- ④ Select the Output rate mode (internal or genlock) with the front panel display menu (**Output > output rate.**).
- ⑤ Select the type of the **RGB/YUV output** with the front panel display menu (**Output > RGB/YUV out.**).
- ⑥ As required, make the following adjustments:
  - Select the UNDERSCAN mode with the front panel display menu (**Image > under/over.**).
  - Adjust the image position & size with the front panel buttons.
  - Adjust the level of anti-flicker with the panel display menu (**Image > flicker filter.**).
  - Make the others adjustments, available in the Image menu.



# QUICK START GUIDE – SCAN 1600

ANALOG WAY

EDITION : 06/07

## CONNECTIONS:

- ① Turn OFF all of your equipment before connecting.
- ② Connect your computer source to the COMPUTER INPUT (HD15) connector or the DVI-D INPUT connector.
- ③ As required, connect a control monitor on the MONITOR OUT (HD15) connector.

**NOTE:** Set the RGB Hi-Z/75 Ω button on Hi-Z if you connect a monitor on the MONITOR OUT connector. If not set it on 75 Ω.

**NOTE:** The MONITOR OUT is available only if the COMPUTER source is analog.

- ④ Connect your display devices (TV monitor, VCR...) to the outputs.
- ⑤ Connect the external power supply to an AC power outlet and to the DC input connector of the SCAN 1600. Then turn ON your input sources and then your display devices.

### • SCAN 1600 connection diagram:

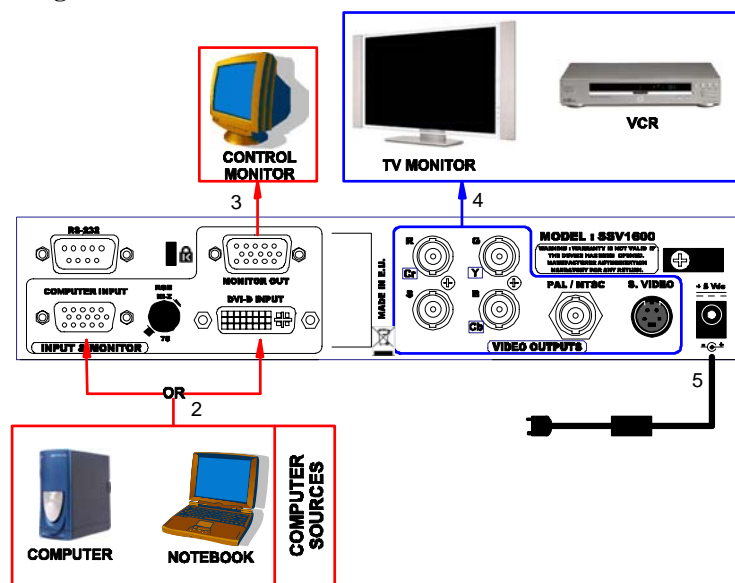

### • RGB/COMPONENT output connection:

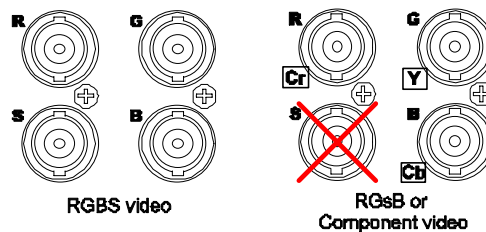

## SETTINGS:

- ① We recommend resetting the SCAN 1600 to all of its default values, with the front panel display menu (**Control > default value > yes**) before proceeding.
- ② Select the Input source (ANALOG or DVI) with the front panel display menu (**Input > Input select.**).
- ③ Select the Output standard with the front panel display menu (**Output > output std.**).
- ④ Select the type of the **RGB/YUV output** with the front panel display menu (**Output > RGB/YUV out.**).
- ⑤ As required, make the following adjustments:
  - Select the UNDERSCAN mode with the front panel display menu (**Image > under/over.**).
  - Adjust the image position & size with the front panel buttons.
  - Adjust the level of anti-flicker with the panel display menu (**Image > flicker filter.**).
  - Make the others adjustments, available in the Image menu.



# SCAN 1600 & DIGI SCAN 1600

## **CHAPTER 1 : INTRODUCTION**

### **1-1. ACCESSORIES SUPPLIED WITH THE DIGI SCAN 1600**

- 1 DIGI SCAN 1600
- 1 AC mains cable.
- 1 VGA cable (HD15 male / HD15 male)
- 1 CD-ROM (Remote Control Software).
- 1 User's Manual.

### **1-2. ACCESSORIES SUPPLIED WITH THE SCAN 1600**

- 1 SCAN 1600
- 1 External power supply
- 1 AC mains cable.
- 1 VGA cable (HD15 male / HD15 male)
- 1 CD-ROM (Remote Control Software).
- 1 User's Manual.

#### **Supplied equipment with the OPT-RMK2 option (Rack Mount Kit):**

- 1 rack tablet.
- 2 screws.

### **1-3. DIGI SCAN 1600 GENERAL INFORMATION**

Digi Scan 1600 by Analog Way is a Professional Scan Converter with Genlock and Digital SDI output to convert PC, Mac or Workstation graphic images up to 1600x1200 at 60Hz into Video. Ready for the new generation of computer graphic cards, Digi Scan 1600 also offers a standard DVI-D input and SDI output for a fully digital signal processing. It is totally Auto-Scan and converts in real time, full screen image, with overscan /underscan and frame freeze functions. Digi Scan 1600 outputs at the same time SDI, RGB/S or YUV, S.Video and Composite in NTSC or PAL (4 pin Mini DIN, BNC). SDI signal is 10 bits, 4.2.2, meeting SMPTE 259 timing specifications. Digi Scan 1600 comes with High performance Genlock to overlay graphics onto incoming Video (with external switcher). All of the Line & Subcarrier phase parameters are adjustable, and meet ITU-R/SMPTE specifications. Genlock uses a Black Burst (or Composite) Video signal. It includes an active loop through to daisy chain other devices. Digi Scan 1600 includes Computer input format memory: User adjustments for up to 16 different input formats are stored in the device permanent memory. It makes this device ideal and very useful for rental or multi-computer applications. Digi Scan 1600 features linear Pan/Zoom up to 500% to display from 100% to 4% of any part of the total input image area. A large range Anti-Flicker (8 levels) enables to find the right settings to match your application. It also offers R, G, B and Black Level adjustments for a precise user color setting. In addition, a loop through out of the RGB input is available for monitoring. User friendly menus displayed on a blue illuminated LCD screen provide clear and simple user controls. Digi Scan 1600 can be fully controlled and updated via RS232 serial COM port. Control software is provided with the device and updates can be downloaded from Analog Way website. Digi Scan 1600 is very easy to use and provides professional high quality Video signal.



## **1-4. SCAN 1600 GENERAL INFORMATION**

Scan 1600 by Analog Way is a Scan Converter to convert PC, Mac or Workstation graphic images up to 1600x1200 at 60Hz into Video. Ready for the new generation of computer graphic cards, it also offers a standard DVI-D input for digital signal. It is totally Auto-Scan and converts in real time, full screen image, with overscan / underscan and frame freeze functions. Scan 1600 outputs simultaneously Composite, S.Video and RGB/S or YUV in NTSC or PAL (4 pin Mini DIN, BNC). Scan 1600 includes Computer input format memory: User Adjustments for up to 16 different input formats are stored in the device permanent memory. It makes this device ideal and very useful for rental or multi-computer applications. Scan 1600 features linear Pan/Zoom up to 500% to display from 100% to 4% of any part of the total input image area. A large range Anti-Flicker processing (8 levels) allows to find easily the right settings to match your application. It also offers R, G, B and Black Level adjustments for a precise user color setting. In addition, a loop through out of the RGB input is available for monitoring. An LCD screen enables an easy navigation through the menus. Scan 1600 can be fully controlled and updated via RS232 serial COM port. Control software is provided with the device and updates can be downloaded from Analog Way website. Scan 1600 is very easy to use and provides a high quality Video signal.

## **1-5. DEVICES & OPTIONS REFERENCES**

REFERENCE	DESIGNATION
DSV1600	DIGI SCAN 1600
SSV1600	SCAN 1600.
OPT-RMK2	Rack Mounting Kit (optional) : allows mounting 2 SSV1600 in 1U 19" rack.

## **1-6. INSTALLATION**

**IMPORTANT:** Please read all the safety instructions (pages 2 to 4) before starting.

- **Table Top Mounting:** The devices can be used directly on a table: they are equipped with 4 plastic feet.
- **Rack Mounting:** The **SCAN 1600** is compatible with a 19" enclosure (optional rack mount kit: OPT-RMK2). To install the device into a 19" rack: Remove the 4 plastic feet, fix the tablet to the device using the front side screw of the device and fix the supplied screw to the bottom. Then attach the device to the rack by using 4 screws in the front panel tablet holes (screws are not included). Connect all of the cables to the device and attach them to the rack with some tie wraps.  
  
The **DIGI SCAN 1600** is compatible with a 19" enclosure. To install the device into a 19" rack: Attach the device to the rack by using 4 screws in the front panel holes (screws are not included). Connect all of the cables to the devices and attach them to the rack with some tie wraps.

- IMPORTANT:**
- **The openings in the rear and side panels are for cooling. Do not cover these openings.**
  - **Be sure that no weight is added onto the device in excess of 2 kg (4.4 lbs.).**
  - **The maximum ambient operating temperature must not exceed 40°C (104°F).**
  - **The rack and all mounted equipment in it must be reliably grounded to national and local electrical codes.**

**1-7. DIGI SCAN 1600 FRONT PANEL DESCRIPTION**

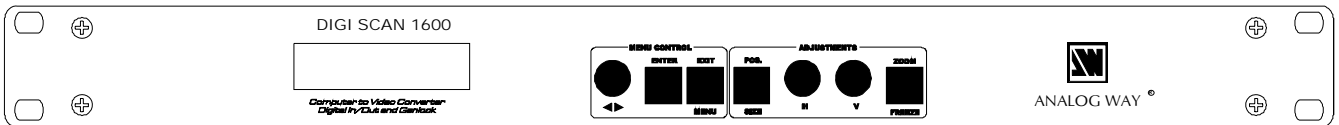

**MENU CONTROL**



Allows to scroll thru the different menus.

**ENTER:**

Validates a selected item.

A long push on this button allows to activate the STANDBY mode. A short push on this push button allows to wake up the device.

**EXIT MENU:**

Allows to exit from a LCD menu.

**ADJUSTMENTS**

**POS. SIZE:**

Position or Size mode selection.

**H:**

Horizontal image adjustment.

**V:**

Vertical image adjustment.

**ZOOM:**

Zoom mode selection (long push)

**FREEZE:**

Freezes the displayed output (short push).

**1-8. DIGI SCAN 1600 REAR PANEL DESCRIPTION**

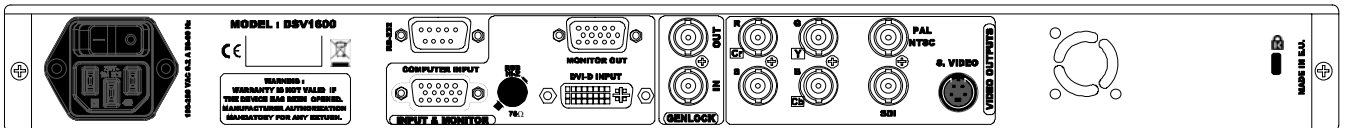

**ON / OFF:**

AC power switch (O = OFF, I = ON).

**POWER:**

Standard IEC connector (100-250 VAC, 0.5A, 50-60Hz automatic).

**RS-232:**

RS-232 communication port on a DB9 female connector.

**INPUT & MONITOR**

**COMPUTER INPUT:** Analog computer input on HD15 female connector.

**DVI-D INPUT:** DVI-D computer input on DVI female connector.

**RGB Hi-Z / 75 Ω:** RGB input load. Set this button on Hi-Z if you connect a monitor on the MONITOR OUT connector. If not set it on 75 Ω.

**MONITOR OUTPUT:** Analog computer output (loop-through) on HD15 female connector.

**GENLOCK**

**IN:** GENLOCK input.

**OUT:** GENLOCK output (loop-through).

**VIDEO OUTPUTS**

**R, G, B, S:** RGB/S or RGsB video outputs (on 3 or 4 BNC connectors).

**Cr, Y, Cb:** Component video (YUV) output (on 3 BNC connectors).

**PAL/NTSC:** Composite video output (on 1 BNC connector).

**SDI:** SD-SDI (4:2:2) output (on 1 BNC connector).

**S.VIDEO:** S.VIDEO output (4-pin mini DIN connector).



**1-9. SCAN 1600 FRONT PANEL DESCRIPTION**

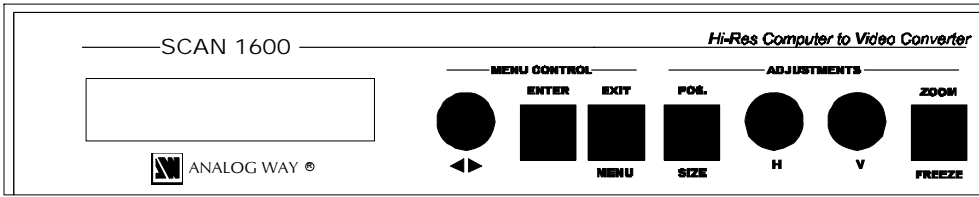

**MENU CONTROL**



Allows to scroll thru the different menus (in Control mode).

**ENTER:**

Validates a selected item.

A long push on this button allows to activate the STANDBY mode. A short push on this push button allows to wake up the device.

**EXIT MENU:**

Allows to exit from a LCD menu.

**ADJUSTMENTS**

**POS. SIZE:**

Position or Size mode selection.

**H:**

Horizontal image adjustment.

**V:**

Vertical image adjustment.

**ZOOM:**

Zoom mode selection (long push)

**FREEZE:**

Freezes the displayed output (short push).

**1-10. SCAN 1600 REAR PANEL DESCRIPTION**

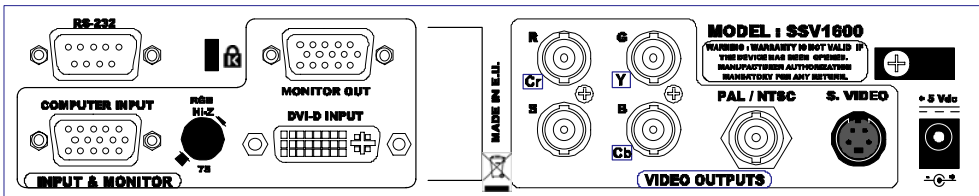

**RS-232:**

RS-232 communication port on a DB9 female connector.

**INPUT & MONITOR**

**COMPUTER INPUT:** Analog computer input on HD15 female connector.

**DVI-D INPUT:** DVI-D computer input on DVI-I female connector.

**RGB Hi-Z / 75 Ω:** RGB input load. Set this button on Hi-Z if you connect a monitor on the MONITOR OUT connector. If not set it on 75 Ω.

**MONITOR OUTPUT:** Analog computer output (loop-through) on HD15 female connector.

**VIDEO OUTPUTS**

**R, G, B, S:** RGB/S or RGsB video outputs (on 3 or 4 BNC connectors).

**Cr, Y, Cb:** Component video output (on 3 BNC connectors).

**PAL/NTSC:** Composite video output (1 BNC connector).

**S.VIDEO:** S.VIDEO output (4-pin mini DIN connector).

**+5 Vdc:**

DC input connector.

## CHAPTER 2 : STARTING

### 2-1. DIGI SCAN 1600 CONNECTIONS:

- ① Turn OFF all of your equipment before connecting.
  - ② Connect the AC power supply cord to the DIGI SCAN 1600 and to an AC power outlet.
  - ③ Connect your computer source to the COMPUTER INPUT (HD15) connector or the DVI-D INPUT connector.
  - ④ As required, connect a control monitor on the MONITOR OUT (HD15) connector.
- NOTE:** Set the RGB Hi-Z/75 Ω button on Hi-Z if you connect a monitor on the MONITOR OUT connector. If not set it on 75 Ω.
- NOTE:** The MONITOR OUT is available only if the COMPUTER source is analog.
- ⑤ Connect your display devices (TV monitor, VCR...) to the outputs (analog or SDI).
  - ⑥ Turn ON the DIGI SCAN 1600 (rear panel switch). Then turn ON your input source and then your display devices.

• DIGI SCAN 1600 connection diagram:

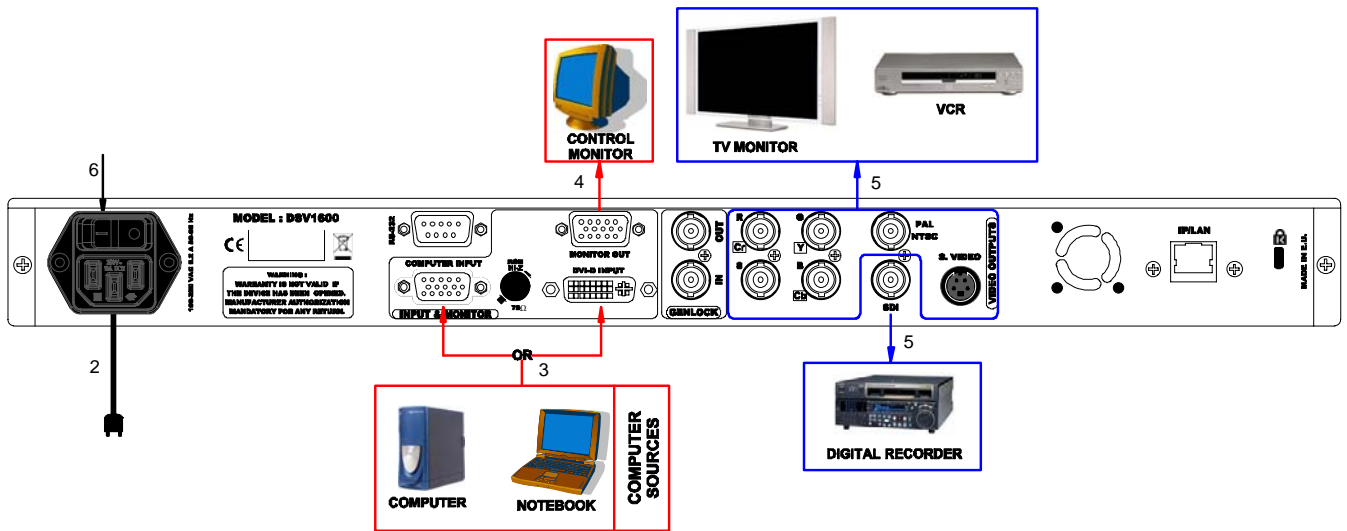

• RGB/COMPONENT output connection:

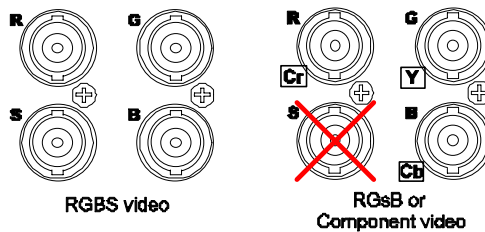

**2-2. SCAN 1600 CONNECTIONS:**

- ① Turn OFF all of your equipment before connecting.
- ② Connect your computer source to the COMPUTER INPUT (HD15) connector or the DVI-D INPUT connector.
- ③ As required, connect a control monitor on the MONITOR OUT (HD15) connector.  
**NOTE:** Set the RGB Hi-Z/75 Ω button on Hi-Z if you connect a monitor on the MONITOR OUT connector. If not set it on 75 Ω.  
**NOTE:** The MONITOR OUT is available only if the COMPUTER source is analog.
- ④ Connect your display device (TV monitor, VCR...) to the outputs.
- ⑤ Connect the external power supply to an AC power outlet and to the DC input connector of the SCAN 1600. Then turn ON your input source and then your display devices.

• **SCAN 1600 connection diagram:**

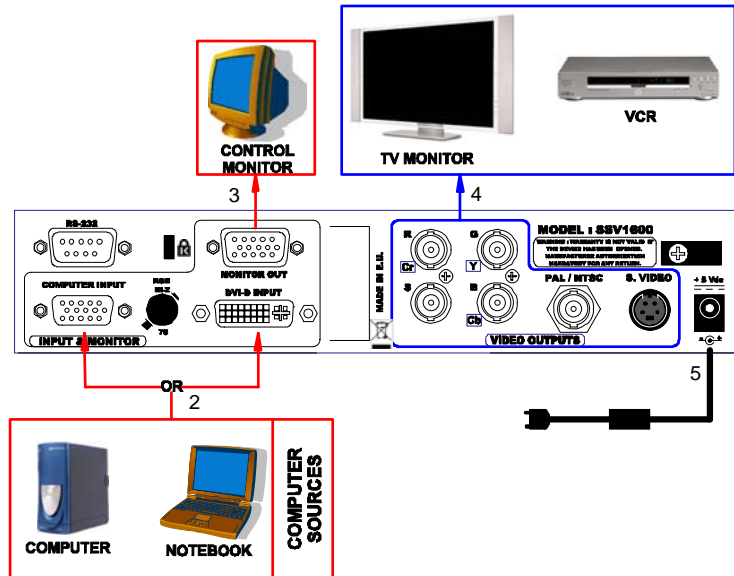

• **RGB/COMPONENT output connection:**

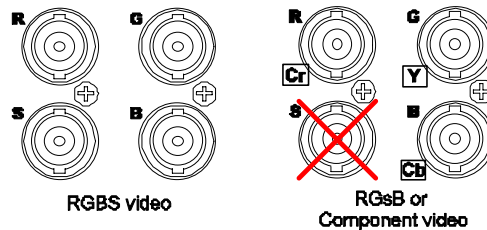

**2-3. SETTINGS**

- ① We recommend resetting the device to all of its default values, with the front panel display menu (**Control > default value > yes**) before proceeding.
- ② Select the Input source (ANALOG or DVI) with the front panel display menu (**Input > Input select.**).
- ③ Select the Output standard with the front panel display menu (**Output > Output std.**).
- ④ Select the type of the **RGB/YUV output** with the front panel display menu (**Output > RGB/YUV out.**).

**2-4. IMAGE ADJUSTMENTS**

- ① Select the UNDERSCAN mode with the front panel display menu (**Image> under/over.**).
- ② Adjust the image position & size with the front panel buttons.
- ③ Adjust the level of anti-flicker with the panel display menu (**Image > flicker filter.**).
- ④ As required, make the others adjustments, available in the Image menu.

## **CHAPTER 3 : FRONT PANEL DISPLAY MENU DESCRIPTION**

### **3-1. INTRODUCTION**

The front panel display menu presents 2 modes: the STATUS MODE and the CONTROL MODE.

- The STATUS MODE indicates the input and output status of the device.
- The CONTROL MODE allows selecting and adjusting the parameters of the device.

### **3-2. CONTROL BUTTONS**

The front panel display is controlled by 2 buttons and 1 knob:

- ◀ ▶ knob:
  - In the CONTROL MODE, turn this knob to scroll thru the different menus.
- ENTER** button:
  - From the STATUS MODE, press this button to enter in the CONTROL MODE.
  - From the CONTROL MODE, press this button to confirm a selected item.
- EXIT / MENU** button:
  - From the STATUS MODE, press this button to enter in the CONTROL MODE.
  - From the CONTROL MODE, press this button to:
    - return to the previous menu without safeguarding the selection.
    - return to the STATUS MODE (press several times).

### **3-3. STATUS MODE**

When switching ON, the front panel display shows the product's name and firmware versions as follows:

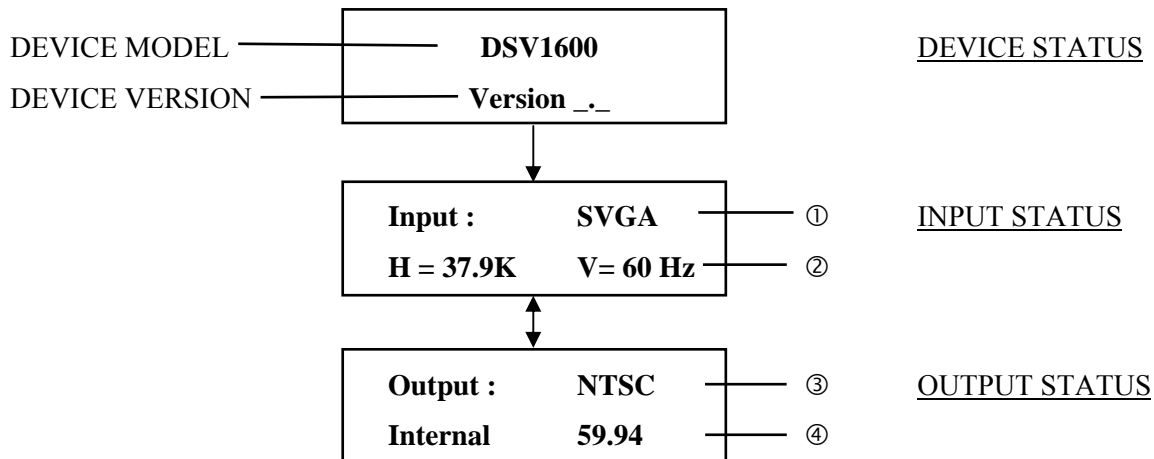

- ① INPUT FORMAT
- ② HORIZONTAL FREQUENCY (in kHz) / VERTICAL FREQUENCY (in Hz).
- ③ OUTPUT STANDARD.
- ④ OUTPUT RATE TYPE / OUTPUT FREQUENCY

**3-4. CONTROL MODE**

The menus of the device are configured as follow:

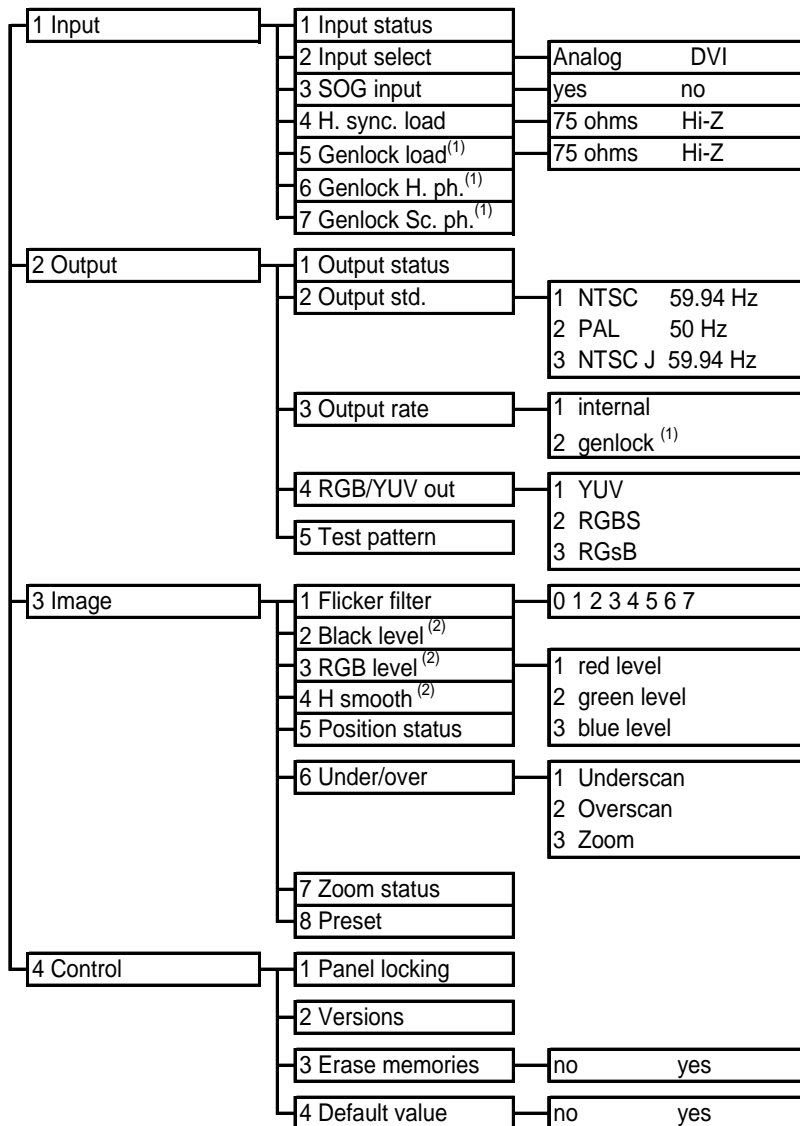

(1) Available on DSV1600 only.

(2) Available for the analog source only.



### **3-5. FUNCTIONS DESCRIPTION**

#### **1 ▶ [INPUT] + ENTER.**

##### **1-1 [Input status] + ENTER.**

Displays the input status.

##### **1-2 [Input type] + ENTER.**

Select one of the following input types with ◀ ▶ + ENTER:

- **[analog]:** Analog computer source connected to the HD15 input connector.
- **[DVI] :** Digital computer source connected to the DVI input connector.

##### **1-3 [SOG input] + ENTER.**

Select [Yes] if your input signal is in RGSB (SOG: Sync On Green), and valid with ENTER.

##### **1-4 [H sync load] + ENTER.**

Select the Horizontal sync load of your input signal with ◀ ▶ + ENTER.

##### **1-5 [Genlock load] + ENTER. (Available on DSV1600 only).**

Set on **Hi-Z** if the genlock out is used.

##### **1-6 [Genlock H. ph.] + ENTER. (Available on DSV1600 only).**

This function allows to adjust the genlock horizontal phase. Adjust with ◀ ▶ + ENTER.

##### **1-7 [Genlock Sc. ph.] + ENTER. (Available on DSV1600 only).**

This function allows to adjust the genlock Subcarrier phase. Adjust with ◀ ▶ + ENTER.

#### **2 ▶ [OUTPUT] + ENTER.**

##### **2-1 [Output status] + ENTER.**

Displays the output status.

##### **2-2 [Output std.] + ENTER.**

Select one of the following standards with ◀ ▶ + ENTER:

- **[NTSC] :** NTSC standard for composite and S.VIDEO output and 60Hz frame rate for RGB/S and YUV output.
- **[PAL] :** PAL standard for composite and S.VIDEO output and 50Hz frame rate for RGB/S and YUV output.
- **[NTSCj] :** NTSC Japan standard for composite and S.VIDEO output and 60Hz frame rate for RGB/S and YUV output.

##### **2-3 [Output rate] + ENTER.**

Select one of the following functions with ◀ ▶ + ENTER.

- **[Internal] :** The output standard depends of the selected output standard menu.
- **[Genlock] :** The output standard is synchronized onto the genlock input standard.

##### **2-4 [RGB/YUV out] + ENTER.**

Select the RGB/YUV wanted output with ◀ ▶ + ENTER.

- **[YUV] :** Component video output.
- **[RGSB] :** RGB/S video output.
- **[RGSB] :** RGB with Sync On Green video output.

##### **2-5 [test pattern] + ENTER.**

Select one item with ◀ ▶ + ENTER.

- **[yes]** = displays a test pattern onto the output.
- **[no]** = turns OFF the test pattern.

**3-5. FUNCTIONS DESCRIPTION (continued)**

**3 [IMAGE] + ENTER.**

**3-1 [Flicker filter] + ENTER.**

Select one of the 8 levels of the anti-flicker with ◀ ▶ and validate with **ENTER**.

**3-2 [Black Level] + ENTER. (Available for analog input source only).**

Adjust the Black level with ◀ ▶ + **ENTER**.

**3-3 [RGB Levels] + ENTER. (Available for analog input source only).**

Select an item with ◀ ▶ + **ENTER**.

- **[Red]** : Adjust the level of the Red with ◀ ▶ + **ENTER**.
- **[Green]** : Adjust the level of the Green with ◀ ▶ + **ENTER**.
- **[Blue]** : Adjust the level of the Blue with ◀ ▶ + **ENTER**.

**3-4 [H. smooth] + ENTER. (Available for the analog input source only).**

Select an item with ◀ ▶ + **ENTER**.

- **[ON]** : Active the horizontal filter.
- **[OFF]** : Inactive the horizontal filter.

**3-5 [Position status] + ENTER.**

Displays the image position status.

**3-6 [Under/over] + ENTER.**

Select an item with ◀ ▶ + **ENTER**.

- **[underscan]** : The output image is full screen.
- **[overscan]** : The output is 10% bigger than in underscan mode.

**3-7 [Zoom status] + ENTER.**

Displays the image zoom status.

**3-8 [Preset] + ENTER.**

This function allows to set all the image parameters (flicker filter, Black level, RGB level, under/overscan, position & size) to the factory settings.

FUNCTION	POSITION	FUNCTION	POSITION
3-1 Flicker Filter	level 1.	3-4 H smooth	off.
3-2 Black level.	0	3-6 under/over	underscan.
3-3 RGB levels.	0	Position & size	0

**4 [CONTROL] + ENTER.**

**4-1 [Panel locking] + ENTER.**

This function allows to lock the front panel buttons. Select an item with ◀ ▶ + **ENTER**.

- **[lock]** : allows to lock the front panel push button.
- **[unlock]** : doesn't lock the front panel button.

**NOTE:** To unlock push simultaneously on **ENTER** and **EXIT**.

**4-2 [Version] + ENTER.**

Status of the internal firmware.

**4-3 [Erase memories] + ENTER.**

This function allows to erase all the image settings memorized.

**4-4 [Default value] + ENTER.**

This function allows to clear the following adjustments and set them to the factory value:

FUNCTION	POSITION	FUNCTION	POSITION
1-2 Input type	analog	2-2 Output standard	NTSC
1-3 SOG input	no.	2-3 Output rate	internal.
1-4 H sync load	Hi-Z.	2-4 RGB/YUV out	YUV
1-5 Genlock load	Hi-Z.	2-5 test pattern	no.
1-6 Genlock H Ph	0	4-1 panel locking	unlock.
1-7 Genlock Sc. Ph.	0		

## **CHAPTER 4 : UPDATING THE DEVICE**

The device can be updated thanks a computer (PC) via its RS-232 communication port.

- ① Power OFF the device.
- ② Connect the RS232 connector of the device to the serial port of your computer with a DB9 M/F straight cable.
- ③ Open the file: Scan 1600.exe (in **Start > Program > ANALOGWAY > SCAN1600 updater**).
- ④ In the **Port** menu select the **Com** port connected to the device.
- ⑤ Click on **START** on the software.
- ⑥ Press and hold the ENTER front panel button, and simultaneously power ON the device. The update will start. Then you can release the ENTER button.
- ⑦ When the software displays: **Program operation completed**, click on the **Quit** button to close the update software. Your device is now ready to work.

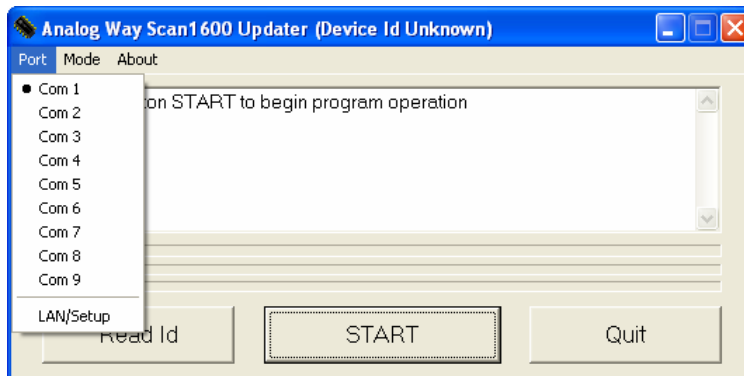

**NOTE:** The updater files are available on our web site: [www.analogway.com](http://www.analogway.com)

## CHAPTER 5 : REMOTE CONTROL SOFTWARE

Your device is shipped with a Windows compatible **Remote Control Software**. This software allows you to control and make all adjustments by a simple mouse click.

**NOTE:** The latest Remote Control Software is available on our web site: [www.analogway.com](http://www.analogway.com)

### 5-1. CONNECTIONS

-Connect the serial port of your control device to the **RS-232** port (DB9 Female connector) of the device with a **straight** cable (DB9 Female / DB9 Male).

-**Speed transmission:** 9600 bauds, 8 data bits, 1 stop bit, no parity bit, no flow control.

-**Pin-out:**

PIN #	FUNCTIONS
2	TRANSMIT DATA (Tx)
3	RECEIVE DATA (Rx)
5	GROUND (Gnd)

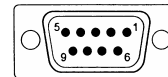

DB9 female (Rear panel of the device)

### 5-2. SOFTWARE INSTALLATION

- ① Turn your computer ON and wait for Windows to completely start.
- ② Insert the CD-ROM into your drive: the ANALOG WAY home window will open automatically.
- ③ Select the language of the CD-ROM menus, then click on "Install a Remote Control Software" and select the name of your device.

**IMPORTANT:** If the Autorun is not enabled: From the Windows desktop, open My Computer and select the CD-ROM drive. Select the Autorun folder, and then select the autorun.exe file.

- ④ Follow the Windows installation instructions.

### 5-3. COMMUNICATION SETUP

- ① Connect the RS-232 cable between the DSV1600/SSV1600 and the control device as indicated in the section 5-1.
- ② Then only power ON all of the devices.
- ③ Click on the program files SCAN1600 in **Start>program>ANALOGWAY>SCAN1600** to run the software.
- ④ Click on **Controls** menu and select **Serial Port**, and then select the **COM** port number corresponding to the connection of the device.

When the communication is established, the message "Device connected" is displayed.

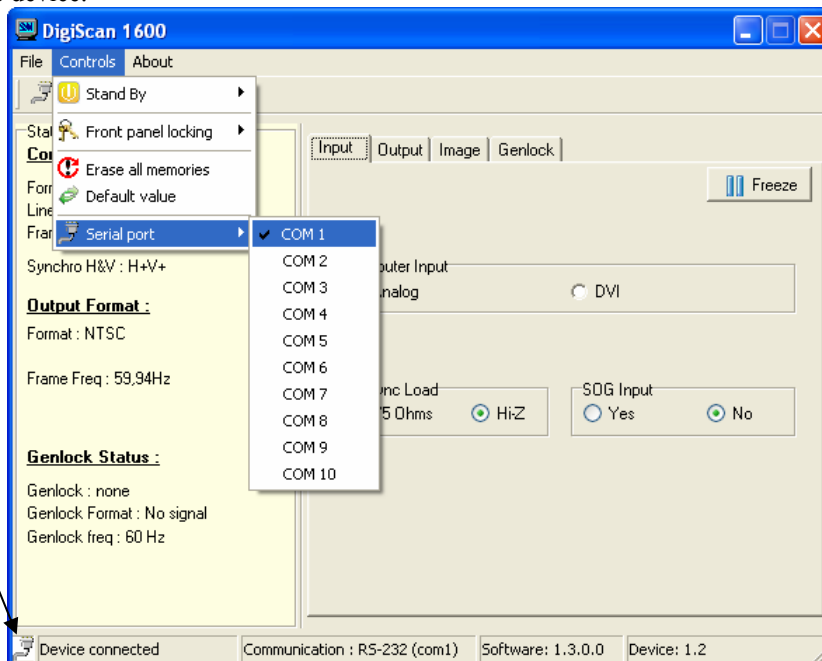

### 5-4. USING THE SOFTWARE

- ① Click on the **Input** tab and select the **Computer input** type.

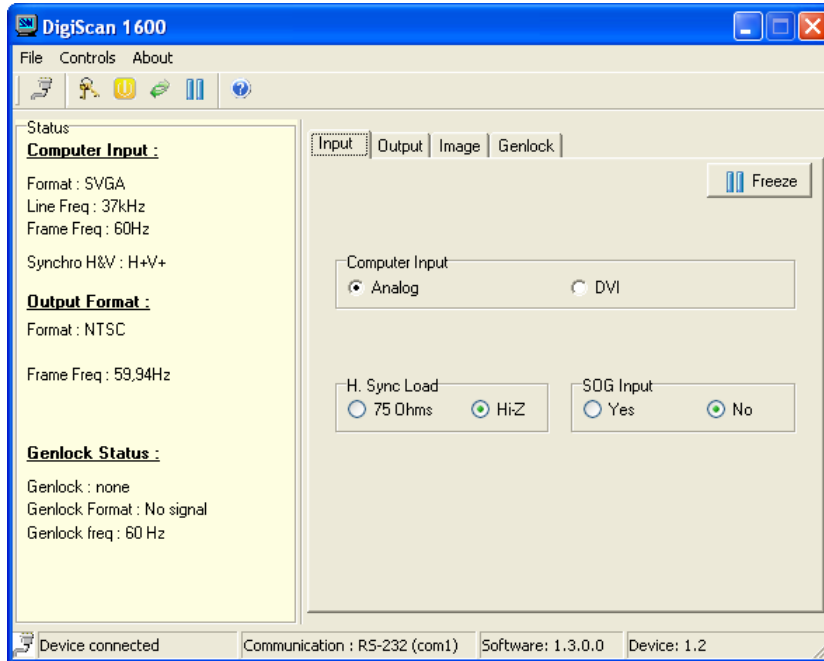

- ② Click on the **Output** tab, and then select the needed adjustment (output standard, output rate...).

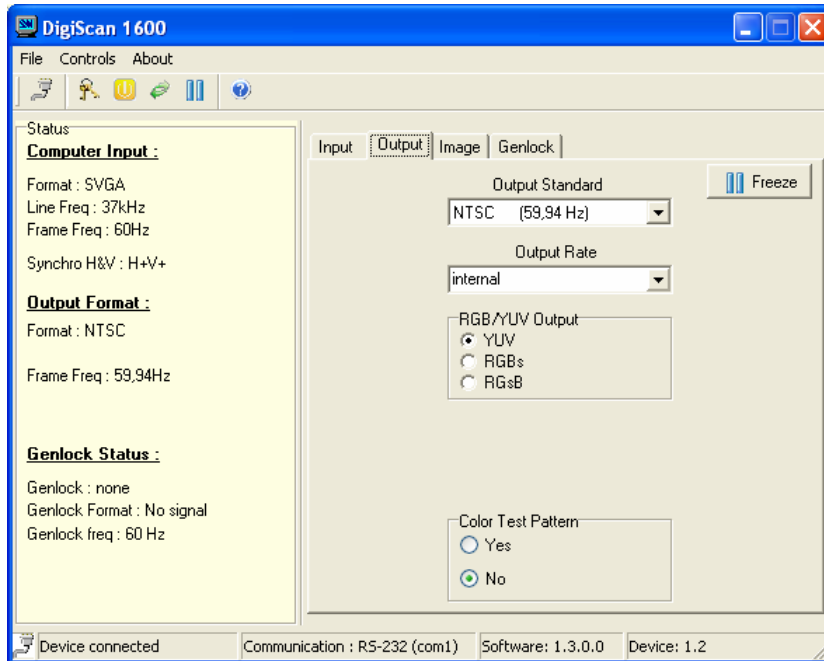

**5-4. USING THE SOFTWARE (continued)**

- ③ Click on the **Image** tab and adjust your input.

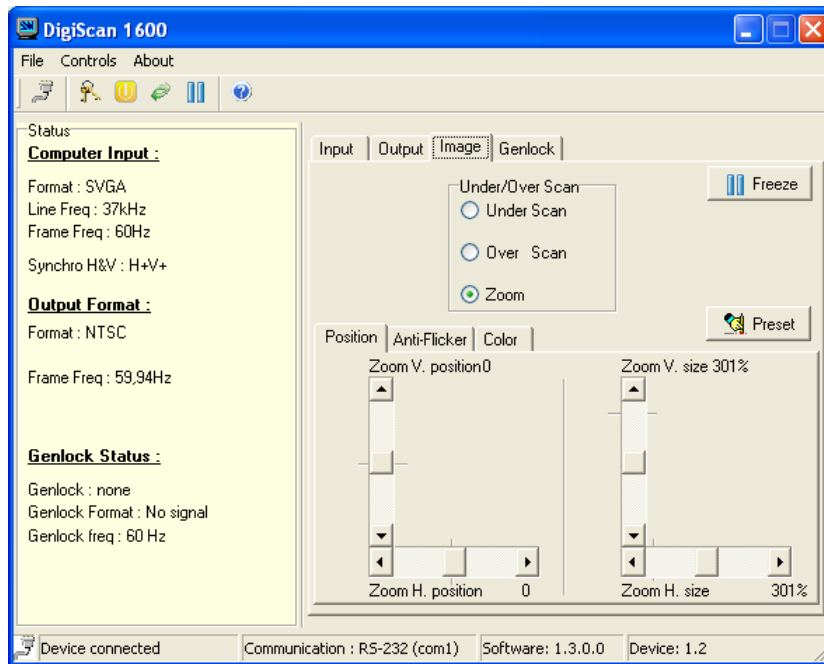

- ④ For the DSV1600 only, click on the Genlock tab and make the genlock adjustments.

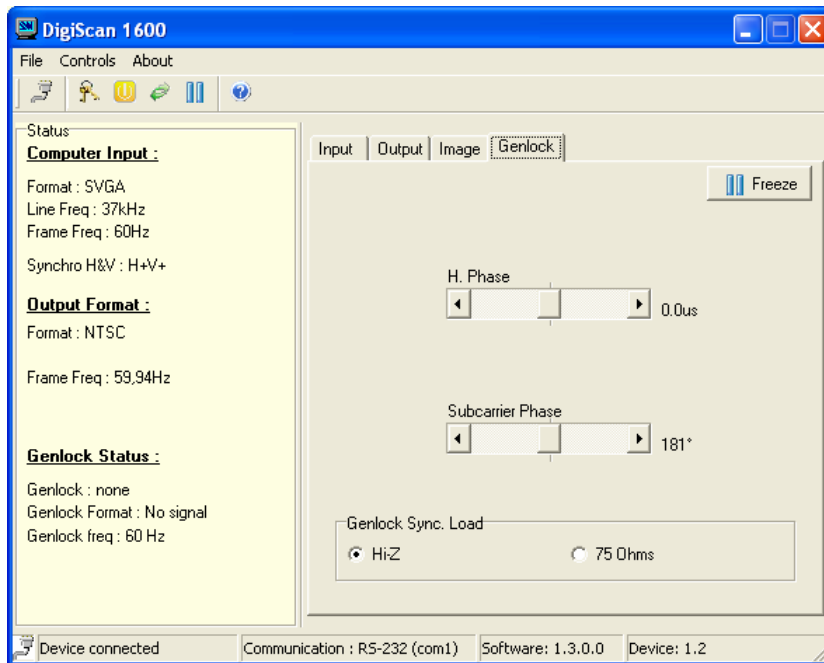

## **CHAPTER 6 : TECHNICAL SPECIFICATIONS**

### **6-1. COMPUTER INPUTS**

#### **• ANALOG COMPUTER INPUT**

<i>Connector:</i>	HD15 female.
<i>Line frequency:</i>	From 29 kHz to 110 kHz.
<i>Frame frequency:</i>	Up to 130 Hz.
<i>Resolution:</i>	Up to 1600 x 1200.
<i>Signal &amp; Sync. type:</i>	RGBHV, RGB/S, RGsB (Sync On Green).
<i>Level:</i>	R, G, B: 0.7 Vp/p. H & V Sync: TTL. Composite Sync: TTL and 0.3 V. SOG (Sync On Green): 0.3 V.
<i>Impedance:</i>	R, G, B: 75 Ohm H: Hi-Z or 75 Ohm. V: Hi-Z

#### **• DIGITAL COMPUTER INPUT**

<i>Connector:</i>	DVI-I female.
<i>Format:</i>	Digital Visual Interface (DVI)
<i>Resolution:</i>	<ul style="list-style-type: none"> <li>• 640 x 480 @ 60Hz (up to 120 Hz).</li> <li>• 800 x 600 @ 60Hz (up to 120 Hz).</li> <li>• 1024 x 768 @ 60Hz (up to 120 Hz).</li> <li>• 1280 x 1024 @ 60Hz (up to 75 Hz).</li> <li>• 1600 x 1200 @ 60Hz RB (Reduced Blanking).</li> </ul>

### **6-2. VIDEO OUTPUTS**

#### **• RGB/S VIDEO**

<i>Connectors:</i>	4 BNC female.
<i>Frequency:</i>	15.625 kHz / 50 Hz (625 lines). 15.734 kHz / 60 Hz (525 lines).
<i>Level:</i>	R, G, B : 0.7 Vp/p. Sync: 5 V TTL. SOG: 0.3 Vp/p.
<i>Impedance:</i>	75 Ohm.

#### **• COMPONENT**

<i>Connectors:</i>	3 BNC female.
<i>Frequency:</i>	15.625 kHz / 50 Hz (625 lines). 15.734 kHz / 60 Hz (525 lines).
<i>Level:</i>	Y: 1 Vp/p (0.7 V Luma + 0.3 V Sync.). Cr, Cb: 0.7 Vp/p.
<i>Impedance:</i>	75 Ohm.

#### **• S.VIDEO**

<i>Connector:</i>	4-pin mini DIN female.
<i>Standard:</i>	PAL : 15.625 kHz / 50 Hz - 625 lines. NTSC : 15.734 kHz / 60 Hz - 525 lines - 7.5 IRE. NTSC J : 15.734 kHz / 60 Hz - 525 lines - 0 IRE.
<i>Level:</i>	Y : 1 Vp/p (0.7 V Luma + 0.3 V Sync.). C : 0.7 Vp/p (0.3 V Chroma Burst).
<i>Impedance:</i>	75 Ohm.



**6-2. VIDEO OUTPUTS (continued)****• COMPOSITE VIDEO**

<i>Connector:</i>	BNC female.
<i>Standard:</i>	PAL : 15.625 kHz / 50 Hz - 625 lines. NTSC : 15.734 kHz / 60 Hz - 525 lines - 7.5 IRE. NTSC J : 15.734 kHz / 60 Hz - 525 lines - 0 IRE.
<i>Level:</i>	1 Vp/p (0.7 V Luma + 0.3 V Sync.).
<i>Impedance:</i>	75 Ohm.

**• SDI (available on the DSV1600 only)**

<i>Connector:</i>	BNC female.
<i>Signal:</i>	270 Mbps serial digital output according to SMPTE 259M.
<i>Impedance:</i>	75 Ohm.

**6-3. GENLOCK**

<i>Connectors:</i>	2 BNC female.
<i>Input signal type:</i>	Black Burst PAL or NTSC.
<i>Impedance:</i>	75 Ohm or Hi-Z.
<i>Output:</i>	Passive loop-through.

**6-4. REMOTE PORT**

<i>Connector:</i>	DB9 female.
<i>Level:</i>	RS-232.
<i>Data Rate:</i>	9600 bauds, 8 bits data, 1 bit stop, no parity bit, no flow control.

**6-5. ENVIRONMENTAL**

<i>Power Supply:</i>	DSV1600 : 100VAC-250VAC ; 50-60Hz ; I = 0.5A Max. SSV1600 : External adapter (CE / UL / CSA / IEC950 approved) Input (AC): 100-240 VAC, 1 A, 50-60 Hz. Output (DC): 5 V, 4A, 20 W max.
<i>Storage Temperature:</i>	- 25 °C to + 85 °C (- 13 °F to + 185 °F)
<i>Operating temperature:</i>	0 °C to + 50 °C (32 °F to 122 °F)
<i>Hygrometry:</i>	10% to 80% (without condensation)
<i>Dimensions:</i>	Compatible with the 19" standard, height = 1 unit. DSV1600: W 482 mm (19") x D 265 mm (10.4") x H 44 mm (1.74"). SSV1600: W 221 mm (8.7") x D 265 mm (10.4") x H 43 mm (1.69").
<i>Weight:</i>	DSV1600: 3 kg (6.6 Lbs). SSV1600: 1.2 kg (2.64 Lbs)

**APPENDIX A: PROGRAMMER'S GUIDE****A-1: INTRODUCTION**

If you need to use your own Software Control program from a PC or WORKSTATION with an RS-232 port, the device allows communication through an ASCII code protocol.

The device treats any character that it receives on the RS-232 as a possible command but only accepts legal commands. There is no starting/ending code needed in a command string.

A command can be a single character typed on a keyboard and does not require any special character before or after it. (It is not necessary to press "ENTER" on the keyboard). A command can be preceded by a value (See chapter A-2: COMMANDS STRUCTURE). When the device receives a valid command, it will execute the command. Then it will send back the status of the parameters that have changed due to this command.

If the command cannot be executed (value out of range, no signal on the selected input), the device will just send back the current status of the corresponding parameters.

If the command is invalid, an error response will be returned to the control device. All responses returned to the control device end with a carriage return <CR> and a line feed <LF> signaling the end of the response character string (see chapter A-3: ERROR RESPONSE).

**A-2: COMMANDS STRUCTURE**

Commands are usually composed of a numerical value followed by the command character. The characters used without any numerical value return the current setting of the command.

Command = Value (optional) + Character.

*Examples / Exemples:*

<b>Command / Commande</b>		<b>Response Réponse</b>	<b>Description</b>
Value/ Valeur	Character / Caractère		
none aucune	F	OFMT1	Read the output format. <i>Lit le type de format.</i>
10	v	VP10	Set the vertical position to 10. <i>Règle la position verticale à 10.</i>

**A-3: ERROR RESPONSE**

When the device receives from the control device an invalid command or value, it returns an error response:

*Example / Exemple:*

<b>Command / Commande</b>		<b>Response Réponse</b>	<b>Description</b>
Value/ Valeur	Character / Caractère		
70260	z	E10	Invalid command. / <i>Commande invalide.</i>

**ANNEXE A: GUIDE DE PROGRAMMATION****A-1: INTRODUCTION**

*Si vous souhaitez utiliser votre propre logiciel de contrôle avec votre PC, MAC ou Station de Travail par un port RS-232, l'appareil peut communiquer par simple émission / réception de caractères ASCII.*

*L'appareil traite tous les caractères reçus sur son port RS-232 comme des commandes possibles; seules certaines commandes sont reconnues et acceptées.*

*Une commande est constituée d'un ou deux caractères sans code de contrôle ni avant, ni après. Il n'est pas nécessaire d'appuyer sur "ENTER" du clavier. Une commande peut être précédée d'une valeur (voir chapitre A-2: STRUCTURE D'UNE COMMANDE).*

*Lorsque l'appareil reçoit une commande valide, il exécute cette commande puis renvoie à l'appareil de contrôle l'état de tous les paramètres qui ont été modifiés suite à l'envoi de cette commande.*

*Si la commande n'est pas reconnue (valeur en dehors de la plage, pas de signal sur l'entrée sélectionnée), l'appareil renvoie uniquement les états des paramètres correspondants.*

*Si la commande est invalide, une réponse d'erreur sera retournée à l'appareil de contrôle. Toute réponse faite à l'unité de contrôle se termine par un retour à la ligne et par un saut de ligne (CR / LF) signalant la fin de la commande de réponse. (Voir chapitre: A-3: RÉPONSE D'ERREUR).*

**A-2: STRUCTURE D'UNE COMMANDE**

*Les commandes sont généralement constituées d'une valeur numérique suivie par 1 ou 2 lettres de commande. Une lettre utilisée sans valeur numérique renvoie l'état de la commande.*

*Commande = Valeur (optionnelle) + Caractère*

**A-3: RÉPONSE D'ERREUR**

*Lorsque l'appareil reçoit de l'appareil de contrôle une valeur ou une commande invalide, il retourne le message d'erreur suivant:*

**A-4: COMMANDS AND RESPONSES TABLE****A-4: TABLE DES COMMANDES ET RÉPONSES**

COMMAND <i>COMMANDE</i>	RESPONSE <i>RÉPONSE</i>	COMMAND DESCRIPTION <i>DESCRIPTION DE LA COMMANDE</i>	TYPE	VALUE /VALEUR			
				MIN	MAX	DESCRIPTION	
<b>FRONT PANEL COMMANDS / COMMANDES DE LA FACE AVANT</b>							
z	FRZ	FREEZE.	Rd/Wr	0	1	0 = freeze inactive	1 = freeze active.
a	ASP	Size mode selection.	Rd/Wr	0	2	0 = underscan. 2 = ZOOM.	1 = overscan.
h	HP	Horizontal position adjustment.	Rd/Wr	0	255		
v	VP	Vertical position adjustment.	Rd/Wr	0	255		
w	HW	Horizontal size adjustment.	Rd/Wr	0	255		
s	VS	Vertical size adjustment.	Rd/Wr	0	255		
H	ZHP	Zoom horizontal position.	Rd/Wr	0	255		
V	ZVP	Zoom vertical position.	Rd/Wr	0	255		
W	ZHW	Zoom horizontal size.	Rd/Wr	0	255	0 = 100%	255 = 500%
S	ZVS	Zoom vertical size.	Rd/Wr	0	255	0 = 100%	255 = 500%
<b>INPUT COMMANDS / COMMANDES D'ENTREE</b>							
D	RGBI	Input type	Rd/Wr	0	1	0 = analog	1 = DVI
GP	REFH	Genlock H phase adjustment	Rd/Wr	0	127	0 = -1.6 $\mu$ s	127 = 1.57 $\mu$ s
GS	REFS	Genlock subcarrier phase adjustment.	Rd/Wr	0	255	0 = -180°	255 = 180°
GL	GLD	Genlock load.	Rd/Wr	0	1	0 = Hi-Z	1 = 75 ohms.
E	SOGI	SOG input selection.	Rd/Wr	0	1	0 = no	1 = yes.
l	LOAD	H sync load selection.	Rd/Wr	0	1	0 = Hi-Z	1 = 75 ohms.
<b>OUTPUT COMMANDS / COMMANDES DE SORTIE</b>							
F	OFMT	Output standard selection	Rd/Wr	0	2	0 = NTSC 1 = PAL 2 = NTSCj.	
GR	REFR	Synchronization mode selection.	Rd/Wr	0	1	0 = internal. 1 = genlock.	
e	OSIG	RGB/YUV output selection.	Rd/Wr	0	2	0 = YUV. 1 = RGBS. 2 = RGSB.	
P	OPAT	Test pattern selection.	Rd/Wr	0	1	0 = no test pattern. 1 = test pattern selected.	
<b>IMAGE COMMANDS / COMMANDES DU MENU IMAGE</b>							
f	FLK	Flicker level selection.	Rd/Wr	0	7		
k	BLK	Black level adjustment	Rd/Wr	0	127	0 = level -64	127 = level 63
r	RLV	Red level adjustment.	Rd/Wr	0	255		
g	GLV	Green level adjustment.	Rd/Wr	0	255		
b	BLV	Bleu level adjustment.	Rd/Wr	0	255		
L	HSMT	Horizontal smooth	Rd/Wr	0	1	0 = OFF	1 = ON.
yp	PRES	PRESET	Rd/Wr	0	1	1 = PRESET (automatic reset).	
<b>CONTROLS COMMANDS / COMMANDES DE CONTRÔLE</b>							
yl	LOCK	Front panel locking selection.	Rd/Wr	0	1	0 = unlocks all buttons. 1 = locks all buttons.	
yc	EPOS	Erase memory.	Rd/Wr	0	1	1 = erase all memories (automatic reset).	
Y	FRES	Default value.	Rd/Wr	0	1	1 = set all the parameters to the default value (automatic reset).	
xu	VERU	Device version	Rd	0	65535	Example: 104 = Version 1.4	
xi	I_	Identification number.	Rd	0	65535	Value displayed in hexadecimal in the device.	
<b>NOTE:</b> Rd = Read only command / <i>Commande de lecture.</i> Rd/Wr = Read and write command / <i>Commande de lecture et d'écriture.</i>							

COMMAND <i>COMMANDE</i>	RESPONSE <i>RÉPONSE</i>	COMMAND DESCRIPTION <i>DESCRIPTION DE LA COMMANDE</i>	TYPE	VALUE / VALEUR		
				MIN	MAX	DESCRIPTION
<b>STATUS COMMANDS / COMMANDES D'ETAT</b>						
U	UNIT	Measures unity in kHz.	<b>Rd</b>	0	65535	
il	ILD	This command allows to calculate the input line frequency in kHz	<b>Rd</b>	0	65535	Line frequency (in kHz) = (UNIT VALUE) ÷ (ILD VALUE).
id	IFD	This command allows to calculate the input frame frequency in Hz.	<b>Rd</b>	0	65535	Frame frequency (in Hz) = (Line frequency in Hz) ÷ (IFD VALUE).
ik	IST	Input sync type detection	<b>Rd</b>	0	3	0 = separate H & V 1 = Composite sync (TTL) 2 = SOG (Sync On Green) 3 = Composite sync (analog)
ip	IPS	Input sync detection.	<b>Rd</b>	0	1	0 = no sync detected    1 = sync detected
ih	IHP	Sign of the horizontal input sync.	<b>Rd</b>	0	1	0 = negative            1 = positive
iv	IVP	Sign of the vertical input sync.	<b>Rd</b>	0	1	0 = negative            1 = positive
ii	IIN	Interlaced signal detection.	<b>Rd</b>	0	1	0 = not interlaced    1 = interlaced
io	IOO	Status of the signal in comparison with the input range frequency.	<b>Rd</b>	0	1	0 = in range            1 = out of range
if	IFA	Input format detection	<b>Rd</b>	0	8	0 = no signal 1 = "out of range" signal. 2 = VGA1 350l 3 = VGA2 400l 4 = VGA3 480l 5 = SVGA 6 = XGA 7 = SXGA 8 = UXGA
GA	REFA	Status of the synchronization mode	<b>Rd</b>	0	2	0 = internal 1 = genlock 2 = wrong signal.
GF	REFP	Status of the synchronized format (genlock).	<b>Rd</b>	0	2	0 = no signal 1 = NTSC 59.94 Hz. 2 = PAL 50 Hz.
GT	REFT	Frame frequency of the synchronized signal (genlock) (in hundredth of Hz)	<b>Rd</b>	0	65535	
<b>NOTE:</b> <b>Rd</b> = Read only command / <i>Commande de lecture.</i> <b>Rd/Wr</b> = Read and write command / <i>Commande de lecture et d'écriture.</i>						

**A-5: ASCII / HEX / DEC TABLE**

**A-5: TABLE ASCII / HEX / DEC**

ASCII	HEX	DEC	ASCII	HEX	DEC	ASCII	HEX	DEC
space	20	32	@	40	64	`	60	96
!	21	33	A	41	65	a	61	97
"	22	34	B	42	66	b	62	98
#	23	35	C	43	67	c	63	99
\$	24	36	D	44	68	d	64	100
%	25	37	E	45	69	e	65	101
&	26	38	F	46	70	f	66	102
'	27	39	G	47	71	g	67	103
(	28	40	H	48	72	h	68	104
)	29	41	I	49	73	i	69	105
*	2A	42	J	4A	74	j	6A	106
+	2B	43	K	4B	75	k	6B	107
,	2C	44	L	4C	76	l	6C	108
-	2D	45	M	4D	77	m	6D	109
.	2E	46	N	4E	78	n	6E	110
/	2F	47	O	4F	79	o	6F	111
0	30	48	P	50	80	p	70	112
1	31	49	Q	51	81	q	71	113
2	32	50	R	52	82	r	72	114
3	33	51	S	53	83	s	73	115
4	34	52	T	54	84	t	74	116
5	35	53	U	55	85	u	75	117
6	36	54	V	56	86	v	76	118
7	37	55	W	57	87	w	77	119
8	38	56	X	58	88	x	78	120
9	39	57	Y	59	89	y	79	121
:	3A	58	Z	5A	90	z	7A	122
;	3B	59	[	5B	91	{	7B	123
<	3C	60	\	5C	92		7C	124
=	3D	61	]	5D	93	}	7D	125
>	3E	62	^	5E	94	~	7E	126
?	3F	63	_	5F	95	DEL	7F	127

## **WARRANTY**

Analog Way warrants the product against any defects in materials and workmanship for a period of three years from the date of purchase (back to the factory).

In the event of any malfunction during the warranty period, Analog Way will, at its discretion, repair or replace the defective units, including free materials and labor.

This warranty does not apply if the product has been:

- improperly installed or abused,
- handled with improper care,
- used or stocked in abnormal conditions,
- modified, opened,
- damaged by fire, war, or Natural disasters (Acts of God).

In no way shall Analog Way be responsible for direct or indirect loss of profit or consequential damages resulting from any defect in this product.

In case of any problem, get the serial number of the unit, a description of the problem, and then call your authorized dealer.